

ELTA >>>
TRADE

PRODUCT GUIDE 2024



**THE
VENTILATION
PEOPLE.**



**REALLY
GOOD
FANS.**

WWW.ELTATRADE.CO.UK



THE VENTILATION PEOPLE.

Brought to you by Elta (who know a thing or two about fans!), Elta Trade was born to provide market leading ventilation solutions to everyone who may need it. Established in 1974, Elta have been manufacturing industrial, commercial, bespoke, and OEM fans globally ever since and are quality experts.

YOUR VENTILATION SPECIALISTS, ON & OFF THE JOB.

We're here for you. If you need help choosing a fan or knowing what the best fix is, speak to us. We pride ourselves on our customer service and are always here to give you advice, whether you're on or off the job!

**RESIDENTIAL
VENTILATION.
BETTER AIR
QUALITY.
WORRY FREE
COMPLIANCE.**



**COMMERCIAL
VENTILATION.
BROUGHT TO
YOU BY ELTA.**



CONTENTS.

OUR PRODUCTS.

Designed & manufactured to the highest standards, we can supply fans to suit your application. If you need more information, such as instruction manuals, you can find everything on our website: www.eltatrade.co.uk.

06



DEXA
dMEV

Decentralised
Mechanical Extract
Ventilation

08



DEXA
HR

Single Room
Heat Recovery
Unit

18



LUXE

High Quality
Intermittent
Extract Fan

20



JETFLOW
SJMF

EC In-line Mixed
Flow Circular Fan

**LOOKING
FOR A
STOCKIST?
VISIT OUR
WEBSITE.**

WWW.ELTRADE.CO.UK



10



DEXA HR Plus+

Single room
heat recovery
unit with
end user
controls and
serviceability

12



MOXA MEV

Centralised
Mechanical
Extract
Ventilation

14



PIV ONE

Loft Mounted
Positive Input
Ventilation Unit

16



PIV ONE Plus+

Loft Mounted
Positive Input
Ventilation Unit
with Heater &
Advanced Control

22

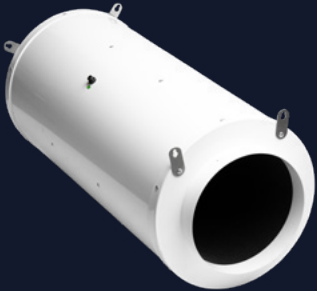

JETFLOW SJMF SILENT

EC Silenced In-line
Mixed Flow Circular Fan

24

COMMERCIAL VENTILATION.

The products in this
guide aren't all we do,
Elta Trade is brought to
you by Elta, meaning we
can supply every kind of
fan for all applications.



26

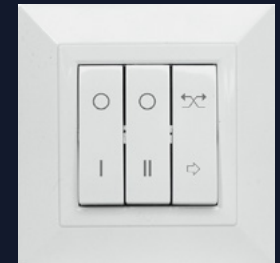

ACCESSORIES



DEXA dMEV

ELTA >>>
TRADE

DEXA dMEV

Decentralised Mechanical Extract Ventilation

Energy saving continuously running trickle & boost extract fan, with intelligent timer and humidity sensor to automatically boost airflow when needed.

IMPROVES INDOOR AIR QUALITY

Better health and reduced heating costs.



Very low power consumption: the EC motor is optimised for continuous running.



Intelligent humidity control increases ventilation only in response to actual variations in humidity, preventing unnecessary heat loss, energy consumption and noisy running.



Intelligent run-on timer adapts the fan operation to the users' habits.



Totally recyclable plastic components; environmentally friendly.

01384 275771
info@eltatrade.co.uk
www.eltatrade.co.uk

**WE COULDN'T FIT
EVERYTHING ON HERE,
SCAN THE QR CODE TO
FIND OUT MORE**



FEATURES & BENEFITS

- **Wall, ceiling and window mountable** (window mounting requires window kit).
- **IPX4** rated.
- **Aesthetic front cover** modern interior fascia design which is easily removed for cleaning without the need for tools.
- **Multi-speed** with adjustable minimum and intermediate speeds.
- **Low power consumption;** optimised for continuous running.
- **Constant flow option;** to speed up or slow down the unit depending on resistances caused by the length of ducting and/or external windy conditions.
- **Intelligent run-on timer** adapts the fan operation to the users' habits. The run-on period depends on the length of time the switched live connection is activated and to ensure the lowest noise levels, especially at night (if switched live connection is activated for less than 3 minutes, the unit speed does not increase).
- **Totally recyclable plastic components;** environmentally friendly.
- **5 year warranty,** for full details, visit www.eltatrade.co.uk.

» **5
YEAR
WARRANTY**

PERFORMANCE DATA

| DEXA dMEV 100 | Min | Max |
|---------------------------------|---------------|------------------|
| Airflow L/s (m ³ /h) | 5 (18) | 25 (90) |
| Power W | 1.0 | 5.8 |
| Sound Pressure dB(A) @ 3m | <9 | 38 |
| Volts | 220-240 | |
| Hertz | 50/60 | |
| Max Ambient Temperature °C | 40 | |
| Degree of Protection | Wall: IPX4 | Ceiling: IPX2 |

For full technical data, please refer to www.eltatrade.co.uk.

DIMENSIONS

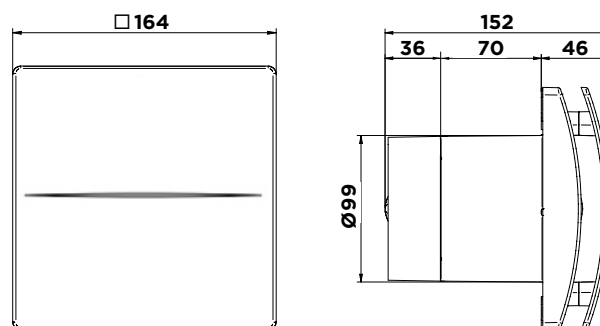

Dimensions in mm.





DEXA HR

ELTA >>>
TRADE

DEXA HR

Single Room Heat Recovery Unit

Alternate flow (“push-pull”) single room heat recovery unit which improves air quality by tackling the causes of condensation and mould while also reducing energy bills.

IMPROVES INDOOR AIR QUALITY

Better health and reduced heating costs.



Helps tackle the causes of condensation and mould.



Very low running costs and also helps save money on your heating.



Extremely quiet.



The removable front fascia makes filter cleaning easy.

01384 275771
info@eltatrade.co.uk
www.eltatrade.co.uk

**WE COULDN'T FIT
EVERYTHING ON HERE,
SCAN THE QR CODE TO
FIND OUT MORE**



FEATURES & BENEFITS

- **Automatically alternates** between supply and extract fan modes every 70 seconds. When in extract mode, the unit's high-efficiency ceramic heat exchanger collects and retains heat from the extracted air. The majority of this heat is then transferred to the incoming air when in supply mode.
- **Multiple unit synchronisation** to work in harmony when installed as a pair. When a unit is extracting in one room, another unit in another room can be set to supply air. This can greatly enhance cross-ventilation and ventilation effectiveness in a home.
- **Free cooling** setting option to prevent heat exchange when not required i.e during the summer (with optional switch accessory).
- **Constant airflow** effectively deals with condensation and mould issues.
- **Aesthetic front cover** modern interior fascia design which is easily removed for cleaning without the need for tools.
- **IPX4** rated.
- **5 year warranty**, for full details, visit www.eltatrade.co.uk.

» **5
YEAR
WARRANTY**

PERFORMANCE DATA

| DEXA HR | 100 | 150 |
|-----------------------------------|-----------------|-----------------|
| Airflow m³/h | 25 / 15 / 10 | 60 / 40 / 20 |
| Power W | 2.6 / 1.7 / 1.2 | 3.8 / 2.3 / 1.4 |
| Sound Pressure dB(A) @ 3m | 29 / 15 / 10 | 26 / 18 / 10 |
| Volts | 220-240 | |
| Hertz | 50 / 60 | |
| Max Ambient Temperature °C | 50 | |
| Degree of Protection | IPX4 | |

Data shown at high / medium / low speed settings.
For full technical data, please refer to www.eltatrade.co.uk.

DIMENSIONS

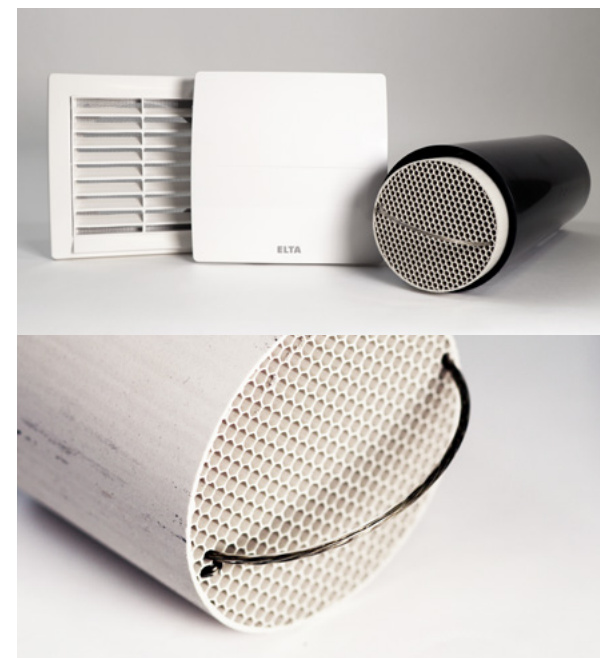
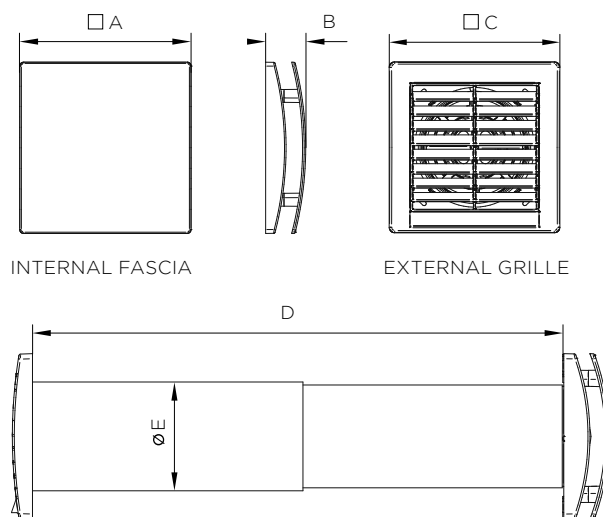

| Model | A | B | C | D | E |
|-------------|-----|----|-----|---------|-----|
| DEXA HR 100 | 164 | 46 | 164 | 270-510 | 108 |
| DEXA HR 150 | 218 | 51 | 218 | 300-560 | 158 |

Dimensions in mm.



DEXA HR Plus+

ELTA >>>
TRADE

DEXA HR Plus+

Single room heat recovery unit with easy to use remote control

Alternate flow (“push-pull”) unit will automatically vary the airflow depending on the mode selected.

IMPROVES INDOOR AIR QUALITY

Better health and reduced heating costs.



Helps tackle the causes of condensation and mould.



Advanced remote control brings further comfort and efficiency settings for the perfect atmosphere.



Very low running costs and also helps save money on your heating.



The magnetic latching removable fascia makes filter cleaning easy.

01384 275771
info@eltatrade.co.uk
www.eltatrade.co.uk

**WE COULDN'T FIT
EVERYTHING ON HERE,
SCAN THE QR CODE TO
FIND OUT MORE**



FEATURES & BENEFITS

- **2 sizes** available to suit application.
- **Constant airflow** effectively deals with condensation and mould issues.
- **Automatic management** of the inversion time (in comfort mode) optimises acoustic and thermal comfort.
- **Smart humidity control.**
- **Easy and safe maintenance** thanks to a magnetic fan faceplate system.
- **Simplified synchronisation** of up to 10 units; thanks to a dedicated communication protocol, the units automatically synchronise when they are wired to each other.
- **Automatic anti-frost protection** prevents frost from building up on the heat exchanger.
- **Free cooling mode** prevents heat exchange when not needed i.e. during the summer.
- **Remote control operation** with the following functions:
 - Airflow direction (alternate, extract only or intake only).
 - Free cooling.
 - ON/OFF and speed (5 options).
 - Comfort/efficiency mode.
 - Boost speed.
 - Filter reset.
- **5 year warranty**, for full details, visit www.eltatrade.co.uk.

PERFORMANCE DATA

| DEXA HR Plus+ | 100 | 150 |
|-----------------------------------|------------------------|-------------------------|
| Airflow m³/h | 25 / 21 / 17 / 14 / 10 | 60 / 50 / 40 / 30 / 20 |
| Power W | 3.5 / 3 / 2.5 / 2 / 2 | 6 / 4.5 / 3.5 / 2.5 / 2 |
| Sound Pressure dB(A) @ 3m | 27 / 23 / 18 / 14 / 9 | 29 / 24 / 20 / 14 / 10 |
| Volts | 220-240 | |
| Hertz | 50 / 60 | |
| Max Ambient Temperature °C | 50 | |
| Degree of Protection | IPX4 | |

Data shown at high to low speed settings.
For full technical data, please refer to www.eltatrade.co.uk.

DIMENSIONS

| Model | A | B | C | D | E | F | G | H | I | J | K |
|-------------------|-----|------|---------|-----|-----|-------|----|----|-----|----|------|
| DEXA HR 100 Plus+ | 218 | 77.5 | 300-570 | 110 | 164 | 117.5 | 39 | 23 | 124 | 44 | 26.5 |
| DEXA HR 150 Plus+ | 218 | 77.5 | 300-570 | 159 | 218 | 117.5 | 39 | 23 | 124 | 44 | 26.5 |

Dimensions in mm.

» **5 YEAR WARRANTY**

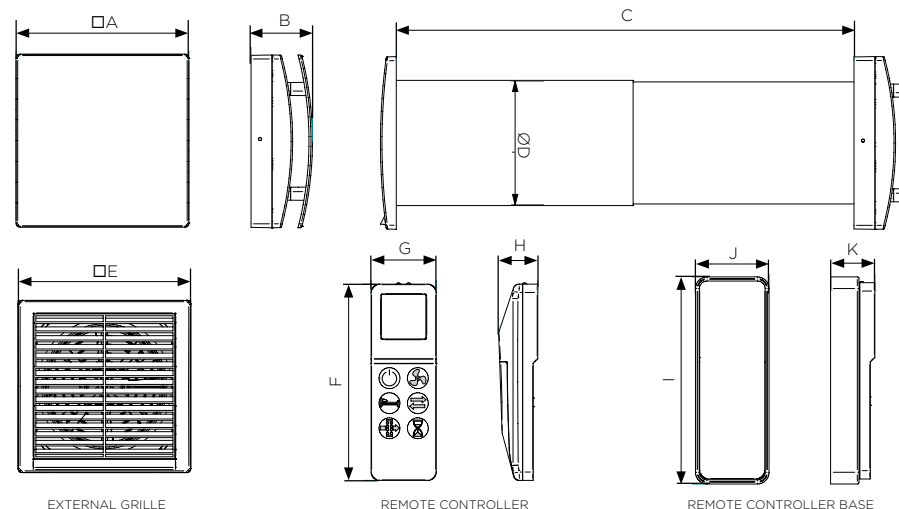

EXTERNAL GRILLE

REMOTE CONTROLLER

REMOTE CONTROLLER BASE



MOXA MEV

ELTA >>>
TRADE





MOXA MEV

Centralised Mechanical Extract Ventilation (MEV)

A continuous running centralised MEV unit extracts the stale air from different rooms at the same time while bringing unparalleled acoustic comfort. The built-in humidity sensor automatically boosts speed when needed.

IMPROVES INDOOR AIR QUALITY

Better health and reduced heating costs.

-  Built-in humidity sensor automatically boosts fan speed when needed.
-  Installation away from the internal grille results in very low noise breakout.
-  Adjustable speed and humidity set point.
-  EC brushless motors significantly reduce electricity consumption.

01384 275771
info@eltatrade.co.uk
www.eltatrade.co.uk

**WE COULDN'T FIT
EVERYTHING ON HERE,
SCAN THE QR CODE TO
FIND OUT MORE**



FEATURES & BENEFITS

- **Easy installation** and straightforward maintenance due to the plug-and-play design.
- **Quiet operation** to reduce disturbance and noise pollution for a peaceful and comfortable living environment.
- **Low energy consumption** from utilising an advanced low-power EC motor that helps save energy without comprising performance. Designed to be energy-efficient, it provides effective ventilation while keeping energy costs down.
- **Continuous running** unit, always removing pollutants, moisture, and odours from the home.
- **Built-in humidity sensor** to detect excess moisture levels and automatically boost its speed by 15% when the threshold is reached. This proactive approach effectively reduces humidity, minimising condensation and preventing mould and mildew growth.
- **Multiple modes of operation** to allow users complete control and installers flexibility for multiple applications.
- **5 year warranty**, for full details, visit www.eltatrade.co.uk.

PERFORMANCE DATA

MOXA MEV

| | |
|---|------------|
| Airflow L/s (m³/h) @100pa | 63.8 (230) |
| Power W | 36 |
| Sound Pressure dB(A) @ 3m | 14 |
| Volts | 220-240 |
| Hertz | 50/60 |
| Max Ambient Temperature °C | 40 |
| Degree of Protection | IPX2 |

For full technical data, please refer to www.eltatrade.co.uk.



DIMENSIONS

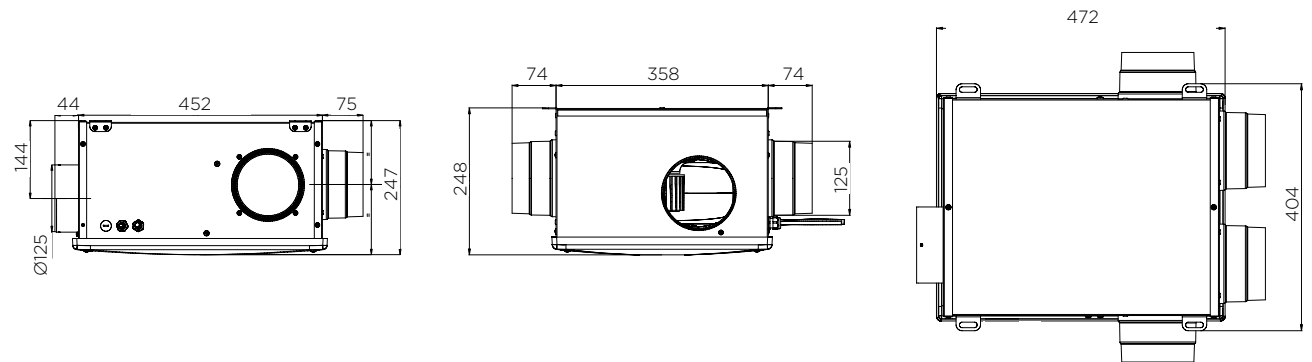



PIV ONE

ELTA >>>
TRADE

PIV ONE

Loft Mounted Positive Input Ventilation Unit

Loft mounted whole-house Positive Input Ventilation unit designed to introduce fresh, clean and filtered air into the dwelling. This dilutes, displaces and replaces the internal stale, contaminated, humid air.

IMPROVES INDOOR AIR QUALITY

Better health and reduced heating costs.



Effective in improving indoor air quality, curing condensation and mould problems, as well as reducing Radon gas concentration.



Two filters to ensure that incoming air is clean; removing dust, pollen and external air pollutants.



EC motor for energy saving and extremely quiet operation.



Additional IAQ filter upgrade available to filter to PM2.5 (diesel particulates).

01384 275771
info@eltatrade.co.uk
www.eltatrade.co.uk

**WE COULDN'T FIT
EVERYTHING ON HERE,
SCAN THE QR CODE TO
FIND OUT MORE**



FEATURES & BENEFITS

- **Highly effective at reducing condensation** and improving indoor air quality.
- **Double filtration** as standard, ensuring that the incoming air is clean, removing dust, pollen and external air pollutants.
- **Washable pre-filter** features an integral magnet system to remove and clean (without tools) easily. This pre-filter stops dust from being pulled into the primary filter, restricting filtration and reducing the filter's lifetime.
- **Internal ISO Coarse 60% (G4) filter** as standard, perfect for dust, mould spores and general pollutants. For high-traffic areas, this can be upgraded to an IAQ filter to remove diesel fumes.
- **Discreet ceiling diffuser** with adjustable blanking plates to direct the airflow to suit the needs of tenants.
- **Pre-wired and pre-mounted fixing points** along with multiple modes of operation selectable at time of deployment mean a fast, versatile installation.
- **Acoustic foam lining** (self-extinguishing) for sound attenuation.
- **5 year warranty**, for full details, visit www.eltatrade.co.uk.

PERFORMANCE DATA

| PIV ONE | Min |
|--|----------|
| Max Airflow L/s (m³/h) @ 100pa | 216 (60) |
| Power W | 24 |
| Sound Pressure dB(A) @ 3m | 27 |
| Volts | 220-240 |
| Hertz | 50/60 |
| Max Ambient Temperature °C | 40 |
| Degree of Protection | IPX2 |

For full technical data, please refer to www.eltatrade.co.uk.

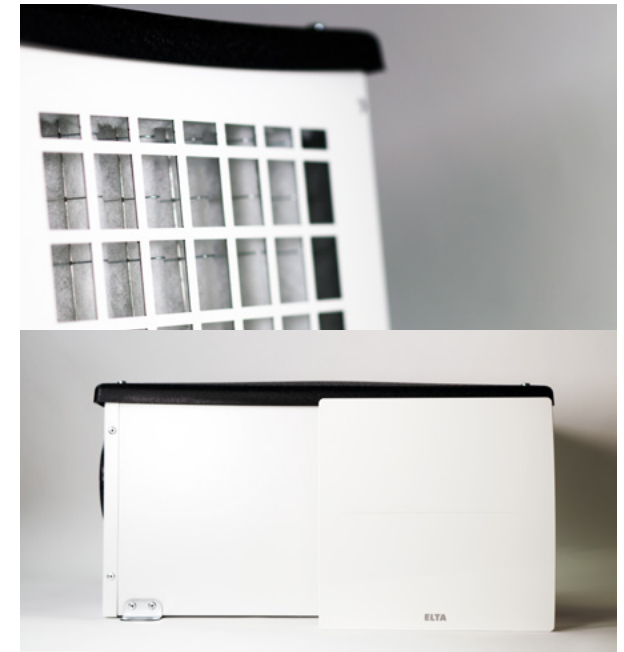

DIMENSIONS

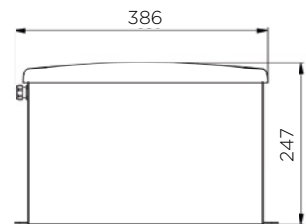

FRONT VIEW

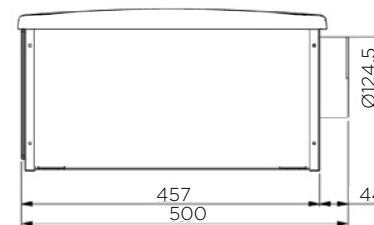

SIDE VIEW

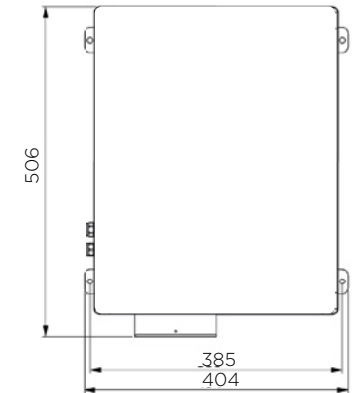

TOP VIEW

Dimensions in mm.

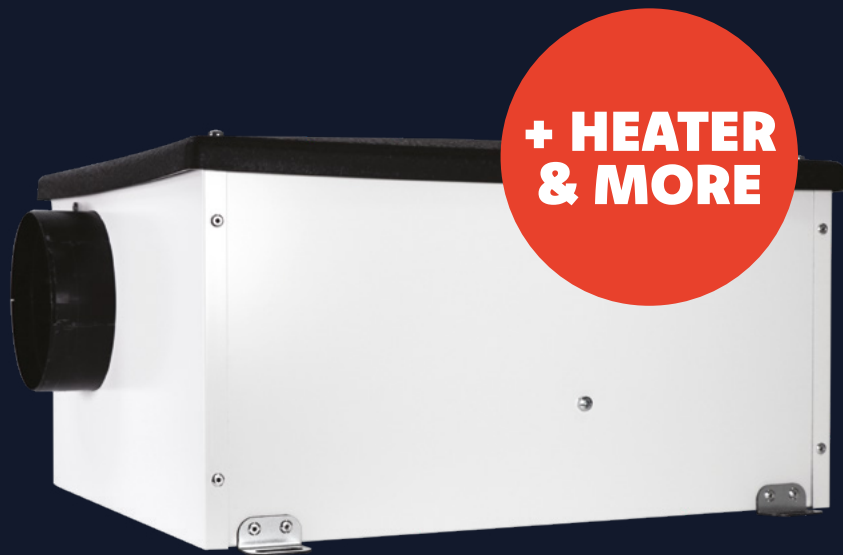

PIV ONE Plus+

ELTA >>>
TRADE

PIV ONE Plus+

Loft Mounted Positive Input Ventilation Unit with Heater & Advanced Control

Whole-house Positive Input Ventilation unit designed to introduce fresh, clean and filtered air into the dwelling. This dilutes, displaces and replaces the internal stale, contaminated, humid air.

IMPROVES INDOOR AIR QUALITY

Better health and reduced heating costs.



Effective in improving indoor air quality, curing condensation and mould problems as well as reducing Radon gas concentration.



Two filters ensure that the incoming air is clean, removing dust, pollen and external air pollutants.



Built-in heater to temper the incoming air for ultimate comfort.



Additional IAQ filter upgrade available to filter to PM2.5 (diesel particulates).

01384 275771
info@eltatrade.co.uk
www.eltatrade.co.uk

**WE COULDN'T FIT
EVERYTHING ON HERE,
SCAN THE QR CODE TO
FIND OUT MORE**



FEATURES & BENEFITS

- **Highly effective at reducing condensation** and improving indoor air quality.
- **Built-in heater** to temper the incoming air for ultimate comfort.
- **Double filtration** as standard, ensuring that the incoming air is clean, removing dust, pollen and external air pollutants.
- **Washable pre-filter** features an integral magnet system to remove and clean (without tools) easily. This pre-filter stops dust from being pulled into the primary filter, restricting filtration and reducing the filter's lifetime.
- **Internal ISO Coarse 60% (G4) filter** as standard, perfect for dust, mould spores and general pollutants. For high-traffic areas, this can be upgraded to an IAQ filter to remove diesel fumes.
- **Discreet ceiling diffuser** with adjustable blanking plates to direct the airflow to suit the needs of tenants.
- **Pre-wired and pre-mounted fixing points** along with multiple modes of operation selectable at time of deployment mean a fast, versatile installation.
- **Acoustic foam lining** (self-extinguishing) for sound attenuation.
- **5 year warranty**, for full details, visit www.eltatrade.co.uk.

»» **5
YEAR
WARRANTY**

PERFORMANCE DATA

| PIV ONE PLUS+ | Min |
|--|----------|
| Airflow L/s (m³/h) @ 100pa | 216 (60) |
| Power W (MAX with heater) | 400 |
| Sound Pressure dB(A) @ 3m | 27 |
| Volts | 220-240 |
| Hertz | 50/60 |
| Max Ambient Temperature °C | 40 |
| Degree of Protection | IPX2 |

For full technical data, please refer to www.eltatrade.co.uk.

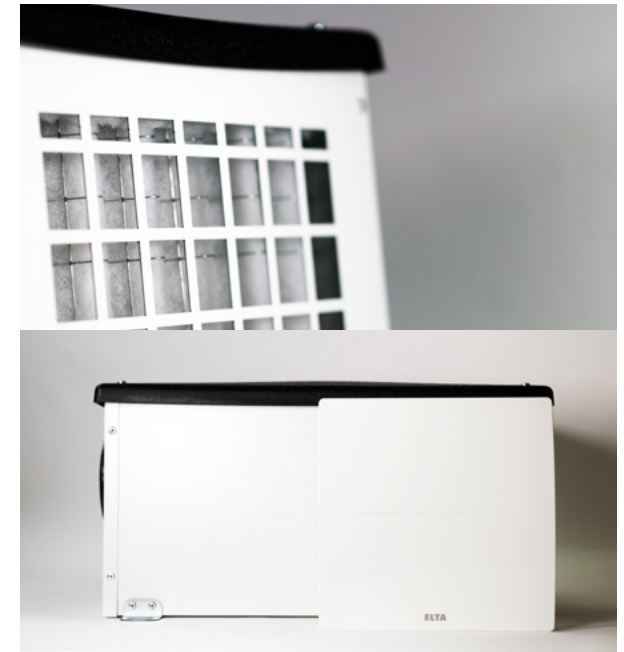

DIMENSIONS

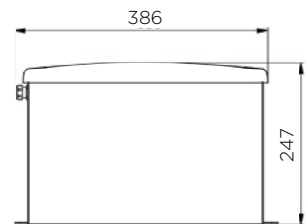

FRONT VIEW

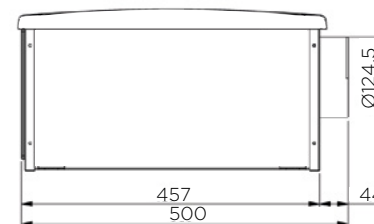

SIDE VIEW

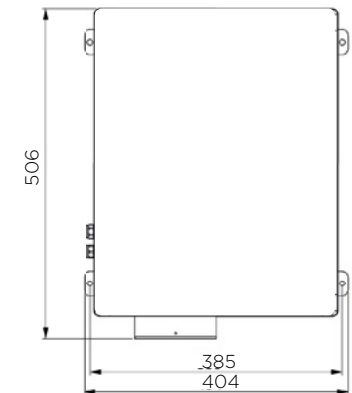

TOP VIEW

Dimensions in mm.



LUXE

ELTA >>>
TRADE

LUXE

High Quality Intermittent Extract Fan

A stylish, contemporary intermittent extract fan. Perfect for wall, ceiling or window mounting, the Luxe extracts directly outside or through short length ducting.

IMPROVES INDOOR AIR QUALITY

Better health and reduced heating costs.



Removable contemporary front cover for easy cleaning.



Integral back-draught shutter.



Low power consumption; the 100mm model consumes less than 8 watts.



100% recyclable plastic components.

01384 275771
info@eltatrade.co.uk
www.eltatrade.co.uk

**WE COULDN'T FIT
EVERYTHING ON HERE,
SCAN THE QR CODE TO
FIND OUT MORE**



FEATURES & BENEFITS

- **Wall, ceiling and window mountable** (window mounting requires window kit).
- **IPX4** rated.
- Available with **adjustable run on timer**.
- Available with **adjustable run on timer and humidity sensor**. The humidity sensor is adjustable from 50% to 95% RH.
- **Aesthetic front cover** for modern interior design which is easily removed for cleaning without the need for tools.
- **Optimised spigot support** design prevents distortion and maximises airflow, while a strengthened guard ensures safety.
- **Integral back-draught shutter** prevents airflow from returning into the room when the fan is not in use.
- **Low power consumption;** the 100mm model uses less than 8 watts of operating power.
- **Totally recyclable plastic components;** environmentally friendly.
- **5 year warranty,** for full details, visit www.eltatrade.co.uk.

PERFORMANCE DATA

| LUXE | 100 | 125 | 150 |
|--------------------------------------|---------|-----|-----|
| Airflow L/s (m³/h) | 83 | 140 | 253 |
| Power W | 8 | 14 | 24 |
| Sound Pressure dB(A) @ 3m | 26 | 34 | 42 |
| Volts | 220-240 | | |
| Hertz | 50/60 | | |
| Max Ambient Temperature °C | 50 | | |
| Degree of Protection | IPX4 | | |

For full technical data, please refer to www.eltatrade.co.uk.

DIMENSIONS

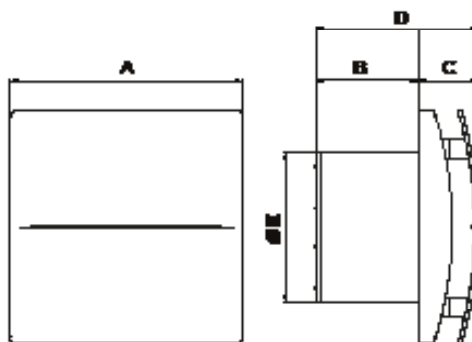

| Model | A | B | C | D | E |
|----------|-----|----|----|-----|-----|
| LUXE 100 | 164 | 70 | 46 | 116 | 99 |
| LUXE 125 | 184 | 81 | 48 | 129 | 119 |
| LUXE 150 | 218 | 97 | 52 | 149 | 148 |

Dimensions in mm.



JETFLOW SJMF

ELTA >>>
TRADE

JETFLOW SJMF

EC Inline Mixed Flow Circular Fan

Compact EC in-line mixed flow fan, designed specifically for use with rigid or flexible ductwork. Perfect for residential, industrial and commercial installations.

IMPROVES INDOOR AIR QUALITY

Better health and reduced heating costs.



Available in 7 sizes from 100mm - 355mm.



Super efficient brushless EC motor results in low SFP even with high performance.



Removing the sound from the room results in increased user comfort.



Easy control with industry-standard 0-10v connection. Allows quick connection to sensors and run-on timers.

01384 275771
info@eltatrade.co.uk
www.eltatrade.co.uk

**WE COULDN'T FIT
EVERYTHING ON HERE,
SCAN THE QR CODE TO
FIND OUT MORE**



FEATURES & BENEFITS

- **EC brushless motor** means even at full speed, it's smooth, quiet and super efficient.
- **Double mixed flow impeller** produces strong pressure at any speed, allowing the fan to be slowed down and deliver the exact performance needed. This saves wasting heat through over-ventilation and reduced consumption.
- **Detachable Bracket** on models 150 to 315mm for ease of installation.
- **Speed controllable** and can be paired with optional accessories and sensors for complete control.
- **Easy Installation;** fitted with a 1.5 metre mains lead complete with UK 3-pin plug. Convenient for connecting to electrical sockets and providing a means of isolation/disconnection.
- **Low power consumption** at high performance resulting in Low Specific Fan Powers for Building Regulation Compliance.
- **2 year warranty,** for full details, visit www.eltatrade.co.uk.

PERFORMANCE DATA

| JETFLOW SJMF | 100 | 125 | 150 | 200 | 250 | 315 | 355 |
|--|-----------------|----------|-----------|-----------|------------|------------|-------------|
| Max Airflow L/s (m³/h) @ 100pa | 48 (173) | 68 (245) | 130 (468) | 253 (911) | 427 (1538) | 773 (2783) | 1140 (4104) |
| Power W | 21 | 27 | 49 | 100 | 172 | 375 | 538 |
| Sound Pressure dB(A) @ 3m | 47 | 48 | 51 | 52 | 56 | 62 | 66 |
| Volts Hertz | 220-240 50/60 | | | | | | |
| Max Ambient Temperature °C Degree of Protection | 60 IPX4 | | | | | | |

For full technical data, please refer to www.eltatrade.co.uk.

DIMENSIONS

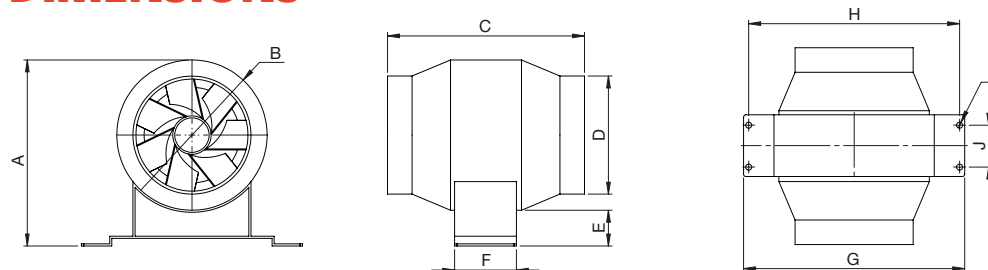

| MODEL | A | B | C | D | E | F | G | H | J | K | Weight kg |
|----------|-----|-----|-----|-----|----|-----|-----|-----|----|-------------|-----------|
| SJMF 100 | 150 | 125 | 159 | 98 | 25 | 51 | 184 | 175 | 37 | 5 | 1.1 |
| SJMF 125 | 151 | 126 | 110 | 124 | 26 | 51 | 184 | 175 | 37 | 5 | 1.1 |
| SJMF 150 | 173 | 153 | 165 | 150 | 21 | 80 | 187 | 175 | 37 | 5 x 8 SLOT | 1.6 |
| SJMF 200 | 223 | 203 | 220 | 200 | 22 | 105 | 221 | 210 | 39 | 5 x 8 SLOT | 2.6 |
| SJMF 250 | 274 | 254 | 210 | 250 | 22 | 105 | 300 | 288 | 26 | 5 x 8 SLOT | 3.7 |
| SJMF 315 | 356 | 317 | 290 | 313 | 39 | 164 | 360 | 336 | 68 | 9 x 14 SLOT | 8.5 |
| SJMF 355 | 401 | 358 | 330 | 353 | 45 | 184 | 405 | 380 | 77 | 9 x 14 SLOT | 12.0 |

Dimensions in mm



JETFLOW SJMF SILENT

ELTA >>>
TRADE

JETFLOW SJMF SILENT

EC Silenced Inline Mixed Flow Circular Fan

EC in-line mixed flow fan with built in silencer, designed specifically for use with rigid or flexible ductwork. Perfect for residential, industrial and commercial installations.

IMPROVES INDOOR AIR QUALITY

Better health and reduced heating costs.



Available in 4 sizes from 150mm - 315mm.



Super efficient brushless EC motor results in low SFP even with high performance.



Removing the sound from the room results in increased user comfort.



Easy control with industry-standard 0-10v connection. Allows quick connection to sensors and run-on timers.

01384 275771

info@eltatrade.co.uk

www.eltatrade.co.uk

**WE COULDN'T FIT
EVERYTHING ON HERE,
SCAN THE QR CODE TO
FIND OUT MORE**



FEATURES & BENEFITS

- **EC brushless motor** means even at full speed, it's smooth, quiet and super efficient.
- **Acoustic enclosure** body reduces noise levels.
- **Double mixed flow impeller** produces strong pressure at any speed, allowing the fan to be slowed down and deliver the exact performance needed. This saves wasting heat through over-ventilation and reduced consumption.
- **Speed controllable** and can be paired with optional accessories and sensors for complete control.
- **Easy Installation;** fitted with a 1.5 metre mains lead complete with UK 3-pin plug. Convenient for connecting to electrical sockets and providing a means of isolation/disconnection.
- **Low power consumption** at high performance resulting in Low Specific Fan Powers for Building Regulation Compliance.
- **2 year warranty,** for full details, visit www.eltatrade.co.uk.

PERFORMANCE DATA

| JETFLOW SJMF SILENT | 150 | 200 | 250 | 315 |
|--|-----------------|-----------|------------|------------|
| Max Airflow L/s (m³/h) @ 100pa | 127 (457) | 248 (893) | 404 (1454) | 756 (2722) |
| Power W | 21 | 27 | 49 | 100 |
| Sound Pressure dB(A) @ 3m | 47 | 48 | 51 | 52 |
| Volts Hertz | 220-240 50/60 | | | |
| Max Ambient Temperature °C Degree of Protection | 60 IPX4 | | | |

For full technical data, please refer to www.eltatrade.co.uk.

DIMENSIONS

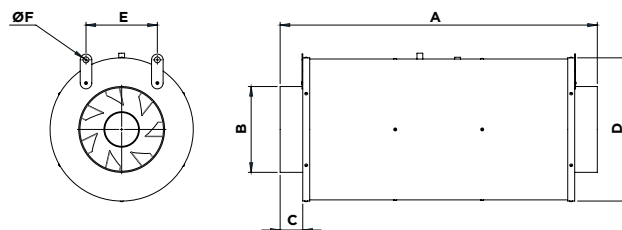

| MODEL | A | B | C | D | E | F | Weight kg |
|-----------|-----|-----|----|-----|-----|----|-----------|
| SJMF150-S | 547 | 148 | 39 | 243 | 123 | 10 | 5 |
| SJMF200-S | 699 | 198 | 40 | 304 | 174 | 10 | 8 |
| SJMF250-S | 859 | 248 | 45 | 353 | 221 | 10 | 14 |
| SJMF315-S | 940 | 313 | 46 | 415 | 268 | 10 | 20 |

Dimensions in mm.



COMMERCIAL VENTILATION.

Elta Trade is brought to you by Elta, meaning not only can we supply the products shown in this guide, which are largely for residential use, but it means we can give you access to fans & ventilation solutions for any job.

You don't need to be an expert on the technical stuff, that's what we're here for.

Elta have been designing and manufacturing market leading ventilation products for over 50 years.

Privately owned and managed with commitment, drive and determination, Elta is an internationally recognised brand committed to leading the world in product and technical ingenuity through our operations in Europe, Asia and Australasia.



ELTA



**DUCTED
FANS.**

**PLATE
FANS.**

**CENTRIFUGAL
FANS.**

**HVLS
FANS.**

**WINDOW /
WALL FANS.**

**+ AHUs
SILENCERS,
ACCESSORIES
& MORE.**

Find out more at
www.eltatrade.co.uk or
www.eltafans.com.



ACCESSORIES.

EVERYTHING YOU NEED TO COMPLETE THE JOB.

From silencers to window kits & controls, we have a range of accessories so you can get everything you need in one place and know they fit our fans.

Our controls are made by our sister company; Aerauliqa, who are based in Brescia, Italy. We only supply products that are tested and trusted by us and we wouldn't trust anyone more than a fellow member of Elta Group.

SILENCERS.

RESIDENTIAL SILENCERS

Designed to reduce noise levels
generated by air movement

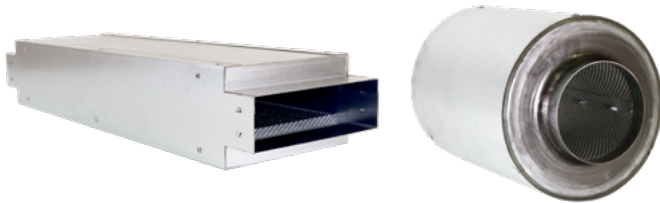

Available for round or rectangular ducting.
High-quality window kit matched to our fans.
Suitable for single, double or triple glazing.
Excellent weatherproofing characteristics.

CEILING GASKET.

CEILING GASKET KIT

Provides IPX4 protection against
moisture in ceiling installations



High-quality ceiling kit to suit our fans.

FILTERS.

HR REPLACEMENT FILTERS

A pack of 3 replacement filters



A pack of 3 replacement filters for the HR
150 Alternate Flow Supply & Extract Fan unit.

CONTROLS.

SEN-HY-I

HUMIDITY SENSOR

Perfect for rooms and areas that are prone to high moisture and condensation



Integral over-run timer adjustable from 1 to 25 minutes.

IP40 protection.

Mounts to a standard single back box for fast installation.

01384 275771

info@eltatrade.co.uk

www.eltatrade.co.uk

CTRL-P1-I

PIV CONTROL SWITCH

Add easy control to your PIV ONE



Fits a standard single back box for fast installation.

Overrides PIV unit's automatic controls when maximum airflow required.

Allows you to manually override the heater for the best efficiency.

CTRL-M-I

MEV CONTROL KNOB WITH SWITCH

Variable speed controller with on/off switch



Precise control.

On/off override.

CTRL-S-I

HR CONTROL SWITCH

Brings manual control to the DEXA HR



Brings complete control to the DEXA HR.

Mounts to a standard single back box for fast installation.

SEN-PIR-I

PIR SENSOR

Add easy occupancy control to any space



4 modes for complete control.

Adjust the time, twilight and motion sensitivity.

Fits a standard single back box for fast installation.

SEL-3V-I

3 SPEED KNOB

3 speed controller for the MOXA MEV



3 speed control.

On/off override





COWL.

COWL WITH NON RETURN FLAP

Standard wall cowl available in 5 colours



Colours Available:

| | |
|------------|---|
| Brown |  |
| Terracotta |  |
| White |  |
| Beige |  |
| Black |  |

The cowl design offers efficient airflow with low resistance.

Available in 100, 125 and 150mm sizes for round or 100x54mm rectangular duct.





GRILLE.

PLASTIC LOUVRED GRILLE

Standard external grille available in 5 colours



Colours Available:

| | |
|------------|---|
| Brown |  |
| Terracotta |  |
| White |  |
| Beige |  |
| Black |  |

The grille design offers efficient airflow with low resistance.

Available in 100, 125 and 150mm sizes for round or 100x54mm rectangular duct.

Built in fly screen





GRILLE.

PLASTIC GRAVITY GRILLE

Standard external grille available in 5 colours



Colours Available:

| | |
|------------|---|
| Brown |  |
| Terracotta |  |
| White |  |
| Beige |  |
| Black |  |

The grille design offers efficient airflow with low resistance.

Available in 100, 125 and 150mm sizes for round or 100x54mm rectangular duct.

01384 275771

info@eltatrade.co.uk

www.eltatrade.co.uk

VALVE.

**ROUND METAL
COATED
EXHAUST VALVE**

Standard round metal white coated
exhaust valve in 3 sizes



Fully adjustable for perfect air balancing

Available in 100, 125 and 150mm sizes.

VALVE.

**ROUND METAL
COATED
SUPPLY VALVE**

Standard round metal white coated
supply valve in 3 sizes



Fully adjustable for perfect air balancing

Available in 100, 125 and 150mm sizes.

KITS.

**WINDOW
KITS**

Allows fitment of our fans to
windows



Available in fixed grille or gravity shutter
options.

DUCTING.

ROUND PVC FLEXIBLE HOSE

Perfect for fan connections to fixed ducting

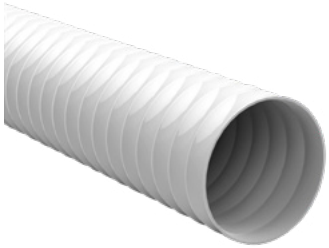

Available in several handy lengths and sizes.
Can also be easily cut to size.

01384 275771
info@eltatrade.co.uk
www.eltatrade.co.uk

ACOUSTIC INSULATED DUCTING

Insulated flexible ducting for the best performance

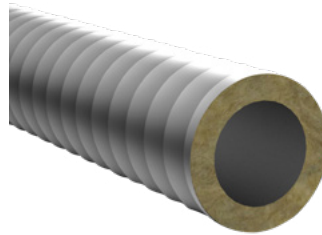

Helps prevent condensation from forming on the outer surface, reducing the risk of moisture-related issues.

Helps minimise heat loss or gain during air transportation, meaning reduced energy consumption and improved overall system efficiency.

The insulation layer helps dampen noise generated by the airflow, for a quieter and more comfortable living or working environment.

DUCTING CLIP

Metal adjustable hose clip for securing connections



Reliable hose clip for fast, secure ducting connections.

DUCTING MOUNTING CLIP

For fast secure ducting installation



Fix with one screw for fast installation.

GALVANISED BANDING REEL

For secure ducting installation to the wall or ceiling



Perfect for fast, strong ducting installations.



NEED AN ACCESSORY YOU DON'T SEE HERE?

This isn't all we do, get in touch to let us know what you need.

GET ONLINE.

**TOOLS TO MAKE
YOUR JOB EASIER.**

WWW.ELTATRADE.CO.UK.

Find details of our trusted stockists, calculate fan running costs, read about air quality and lots more on our website.

PRODUCT DOWNLOADS.

From performance data, to dimensional drawings and installation instructions - find it all on our website.



WE'RE EDATA & LUCKINSLIVE MEMBERS.

If you're a wholesaler using EDATA or LuckinsLive, you can find our products on their database with handy links to web pages, product codes and images.

01384 275771

info@eltatrade.co.uk

www.eltatrade.co.uk

THE FLUFFY STUFF.

THAT WE'D LOVE
YOU TO READ.

A FAN COMPANY.

Elta Trade specialises in residential ventilation that is available to electricians, plumbers, homeowners, and more through electrical wholesalers. Our fans and ventilation products are developed and manufactured in our own manufacturing facilities located across the UK & beyond.

BUT NOT JUST A FAN COMPANY.

With us, it's personal, meaning you can expect the best quality every single time. We pride ourselves on being more than just a fan company, with the highest levels of customer service, infinite knowledge from our ventilation experts, and a deep understanding of building regulations to ensure compliance. You can put your trust in us.

ELTA

THE VENTILATION PEOPLE.

Brought to you by Elta (who know a thing or two about fans!), Elta Trade was born to provide market leading ventilation solutions to everyone who may need it. Established in 1974, Elta have been manufacturing industrial, commercial, bespoke, and OEM fans globally ever since.



01384 275771
info@eltatrade.co.uk
www.eltatrade.co.uk

Issue C. 10.24.